



SPLENDOR HARDWARE



u mu
t mt
t m t
t m M t
m
tt mt t
t t mt t
u mu
t mt

Tuscany - STRAIGHT Edge - Standard Duty

TUSCANY	Wall Hinge - Full Back Plate Finish		Stock
TUS-110F		CH \$23.83	X
GEN037		BN \$23.83	X
		RB \$25.81	X
		PN \$25.81	X
		MB \$25.81	X
		BBRZ \$30.32	X
		BSB \$30.32	X

TUSCANY	Wall Hinge - Short Back Plate Finish		Stock
TUS-110S		CH \$24.83	X
GEN074		BN \$24.83	X
		RB \$26.81	X
		PN \$26.81	X
		MB \$26.81	X
		BBRZ \$31.32	X
		BSB \$31.32	X

TUSCANY	Wall Hinge - Offset Back Plate Finish		Stock
TUS-110T		CH \$24.83	X
GEN044		BN \$24.83	X
		RB \$26.81	X
		PN \$26.81	X
		MB \$26.81	X
		BBRZ \$31.32	X
		BSB \$31.32	X

TUSCANY	GTG Hinge - 180°	Finish	Stock
TUS-180		CH \$36.20	X
GEN180		BN \$36.20	X
		RB \$42.12	X
		PN \$42.12	X
		MB \$39.80	X
		BBRZ \$48.98	X
		BSB \$48.98	X

TUSCANY	GTG Hinge - 90°	Finish	Stock
TUS-190		CH \$43.65	X
GEN092		BN \$44.66	X
		RB \$44.66	X
		PN \$48.15	X
		MB \$44.66	X
		BBRZ \$48.15	X
		BSB \$48.15	X

TUSCANY	GTG Hinge - 135°	Finish	Stock
TUS-335		CH \$46.83	X
GEN345		BN \$47.63	X
		RB \$47.63	
		PN \$50.77	
		MB \$47.03	X
		BBRZ \$50.77	
		BSB \$50.77	

Adjustable Only

TUSCANY	Wall Hinge - FB Plate - 5°	Finish	Stock
TUS-510F		CH \$24.83	X
GEN537		BN \$24.83	X
		RB \$25.81	X
		PN \$25.81	X
		MB \$25.81	X
		BBRZ \$31.32	X
		BSB \$31.32	X

TUSCANY	Wall Hinge - Short Back Plate - 5°	Finish	Stock
TUS-510S		CH \$25.83	X
GEN537		BN \$25.83	X
		RB \$26.81	X
		PN \$26.81	X
		MB \$26.81	X
		BBRZ \$32.32	X
		BSB \$32.32	X

TUSCANY	Wall Hinge - Offset Back Plate - 5°	Finish	Stock
TUS-510T		CH \$25.83	X
GEN537		BN \$25.83	X
		RB \$26.81	X
		PN \$26.81	X
		MB \$26.81	X
		BBRZ \$32.32	X
		BSB \$32.32	X

Pricing is subject to change without notice.

Tuscany - STRAIGHT Edge - Adjustable - Standard Duty

TUSCANY	Wall Hinge - Full Back Plate	Finish	Stock
TUS-310F		CH \$33.12	X
GEN337		BN \$33.76	X
		RB \$33.76	X
		PN \$33.76	X
		MB \$33.76	X
		BBRZ \$36.62	X
		BSB \$36.62	X

TUSCANY	Wall Hinge - Offset Back Plate	Finish	Stock
TUS-310T		CH \$34.12	X
GEN344		BN \$34.76	X
		RB \$34.76	X
		PN \$34.76	X
		MB \$34.76	X
		BBRZ \$37.62	X
		BSB \$37.62	X

TUSCANY	Wall Mount- Short Back Plate	Finish	Stock
TUS-310S		CH \$34.12	X
		BN \$34.76	X
		RB \$34.76	X
		PN \$34.76	X
		MB \$34.76	X
		BBRZ \$37.62	X
		BSB \$37.62	X

TUSCANY	GTG Hinge - 180°	Finish	Stock
TUS-380		CH \$54.28	X
GEN380		BN \$55.26	X
		RB \$55.26	X
		PN \$55.26	X
		MB \$55.26	X
		BBRZ \$58.78	X
		BSB \$58.78	X

TUSCANY	GTG Hinge - 135°	Finish	Price
TUS-335		CH \$46.83	X
GEN345		BN \$47.63	X
		RB \$47.63	X
		PN \$50.77	X
		MB \$47.62	X
		BBRZ \$50.77	X
		BSB \$50.77	X

Pricing is subject to change without notice.

Cypress - BEVELED Edge - Standard Duty

CYPRESS	Wall Hinge - H Back Plate	Finish	Stock
CYP-110H		CH \$25.87	X
P1N037		BN \$26.46	X
		RB \$28.50	X
		PN \$28.88	X
		MB \$26.46	X
		BBRZ \$31.32	X
		BSB \$31.32	X

CYPRESS	Wall Hinge - Short Back Plate	Finish	Stock
CYP-110S		CH \$26.87	X
P1N074		BN \$27.46	X
		RB \$29.50	X
		PN \$29.88	X
		MB \$27.46	X
		BBRZ \$32.32	X
	BSB \$32.32	X	

CYPRESS	Wall Hinge - Offset Back Plate	Finish	Stock
CYP-110T		CH \$26.87	X
P1N044		BN \$27.46	X
		RB \$29.50	X
		PN \$29.88	X
		MB \$27.46	X
		BBRZ \$32.32	X
		BSB \$32.32	X

CYPRESS	GTG Hinge - 180°	Finish	Stock
CYP-180		CH \$38.20	X
P1N180		BN \$38.20	X
		RB \$44.12	X
		PN \$44.12	X
		MB \$41.80	X
		BBRZ \$50.98	X
		BSB \$50.98	X

CYPRESS	GTG Hinge - 90°	Finish	Stock
CYP-190		CH \$48.65	X
P1N092		BN \$49.66	X
		RB \$49.66	X
		PN \$53.15	X
		MB \$49.66	X
		BBRZ \$53.15	X
		BSB \$53.15	X

CYPRESS	GTG Hinge - 135°	Finish	Stock
CYP-335		CH \$50.18	X
P1N345		BN \$51.04	X
		RB \$51.04	X
		PN \$53.04	X
		MB \$51.04	X
		BBRZ \$54.40	X
		BSB \$54.40	X

Adjustable Only

Pricing is subject to change without notice.

Cypress - BEVELED Edge - Adjustable - Standard Duty

CYPRESS	Wall Hinge - H Back Plate	Finish	Stock
CYP-310H		CH \$35.90	X
P1N337		BN \$36.27	X
		RB \$36.27	X
		PN \$37.27	X
		MB \$36.27	X
		BBRZ \$39.36	X
		BSB \$39.36	X

CYPRESS	Wall Hinge - Offset Back Plate	Finish	Stock
CYP-310T		CH \$36.80	X
P1N344		BN \$37.27	X
		RB \$37.27	X
		PN \$38.27	X
		MB \$37.27	X
		BBRZ \$40.36	X
		BSB \$40.36	X

CYPRESS	Wall Mount - Short Back Plate	Finish	Stock
CYP-310S		CH \$36.90	X
		BN \$37.27	X
		RB \$37.27	X
		PN \$38.27	X
		MB \$37.27	X
		BBRZ \$40.36	X
		BSB \$40.36	X

CYPRESS	Wall Hinge - 180°	Finish	Stock
CYP-380		CH \$57.28	X
P1N-380		BN \$58.26	X
		RB \$58.26	X
		PN \$58.26	X
		MB \$58.26	X
		BBRZ \$61.78	X
		BSB \$61.78	X

CYPRESS	GTG Hinge - 135°	Finish	Price
CYP-335		CH \$50.18	X
P1N345		BN \$51.04	X
		RB \$51.04	X
		PN \$53.04	X
		MB \$51.04	X
		BBRZ \$54.40	X
		BSB \$54.40	X

Adjustable
Only

Pricing is subject to change without notice.

Venice - STRAIGHT Edge - Heavy Duty

VENICE	Wall Hinge - Full Back Plate	Finish	Stock
VEN-110F		CH \$34.12	X
V1E037		BN \$34.84	X
		RB \$38.50	X
		PN \$38.50	X
		MB \$34.84	X
		BBRZ \$39.23	X
		BSB \$39.23	X

VENICE	Wall Hinge - Offset Plate	Finish	Stock
VEN-110T		CH \$35.12	X
V1E044		BN \$35.84	X
		RB \$38.50	X
		PN \$38.50	X
		MB \$35.84	X
		BBRZ \$40.23	X
		BSB \$42.23	X

VENICE	Wall Hinge - Short Back Plate	Finish	Stock
VEN-110S		CH \$35.122	X
V1E074		BN \$35.84	X
		RB \$39.50	X
		PN \$39.50	X
		MB \$35.84	X
		BBRZ \$40.23	X
		BSB \$40.23	X

VENICE	GTG Hinge - 180°	Finish	Stock
VEN-180		CH \$48.20	X
V1E180		BN \$78.20	X
		RB \$54.12	X
		PN \$54.12	X
		MB \$50.80	X
		BBRZ \$52.98	X
		BSB \$52.98	X

VENICE	GTG Hinge - 90°	Finish	Stock
VEN-190		CH \$54.72	X
V1E92		BN \$56.36	X
		RB \$56.36	X
		PN \$58.36	X
		MB \$56.36	X
		BBRZ \$58.85	X
		BSB \$58.85	X

VENICE	GTG Hinge - 135°	Finish	Stock
VEN-335		CH \$63.06	X
V1E345		BN \$64.86	X
		RB \$64.86	X
		PN \$67.50	X
		MB \$64.86	X
		BBRZ \$67.50	X
		BSB \$67.50	X

Adjustable Only

Athens - STRAIGHT Edge - Extra Heavy Duty

ATHENS	Wall Hinge - Full Back Plate	Finish	Stock
ATH - 110F		CH \$55.75	X
VCT-037		BN \$57.50	X
		RB \$62.50	X
		PN \$62.50	X
		MB \$57.50	X
		BBRZ \$61.20	X
		BSB \$61.20	X

Pricing is subject to change without notice.

Venice - STRAIGHT Edge - Adjustable Heavy Duty

VENICE	Wall Hinge - Full Back Plate	Finish	Stock
VEN-310F		CH \$42.10	X
V1E337		BN \$42.36	X
		RB \$42.36	X
		PN \$44.20	X
		MB \$42.36	X
		BBRZ \$47.10	X
		BSB \$47.10	X

VENICE	Wall Mount Offset Back Plank	Finish	Stock
VEN-310T		CH \$43.10	X
V1E344		BN \$43.36	X
		RB \$43.36	X
		PN \$44.20	X
		MB \$43.36	X
		BBRZ \$48.10	X
		BSB \$48.10	X

VENICE	Wall Mount Short Back Plate	Finish	Stock
VEN-310S		CH \$43.10	X
		BN \$43.36	X
		RB \$43.36	X
		PN \$44.20	X
		MB \$43.36	X
		BBRZ \$48.10	X
		BSB \$48.10	X

VENICE	GTG Hinge - 180°	Finish	Stock
VEN-380		CH \$64.15	X
V1E380		BN \$64.95	X
		RB \$64.95	X
		PN \$66.95	X
		MB \$64.94	X
		BBRZ \$72.10	X
		BSB \$72.10	X

VENICE	GTG Hinge - 135°	Finish	Price
VEN-335		CH \$63.00	X
V1E345		BN \$64.86	X
		RB \$64.86	X
		PN \$67.50	X
		MB \$64.86	X
		BBRZ \$67.50	X
		BSB \$67.50	X

Pricing is subject to change without notice.

Munich - BEVELED Edge - Heavy Duty

MUNICH	Wall Hinge - H Back Plate	Finish	Stock
MUN-110H		CH \$35.90	X
COL037		BN \$36.12	X
		RB \$36.12	X
		PN \$39.12	X
		MB \$36.12	X
		BBRZ \$41.23	X
		BSB \$41.23	X

MUNICH	Wall Hinge - Offset Plate	Finish	Stock
MUN-110T		CH \$36.90	X
COL044		BN \$37.12	X
		RB \$37.12	X
		PN \$40.12	X
		MB \$37.12	X
		BBRZ \$42.25	X
		BSB \$42.23	X

MUNICH	Wall Hinge - Short Back Plate	Finish	Stock
MUN-110S		CH \$36.90	X
COL074		BN \$37.12	X
		RB \$37.12	X
		PN \$40.12	X
		MB \$37.12	X
		BBRZ \$42.23	X
		BSB \$42.23	X

MUNICH	GTG Hinge - 180°	Finish	Stock
MUN-180		CH \$50.20	X
COL180		BN \$50.20	X
		RB \$56.12	X
		PN \$52.80	X
		MB \$56.09	X
		BBRZ \$59.98	X
		BSB \$59.98	X

MUNICH	GTG Hinge - 90°	Finish	Stock
MUN-190		CH \$56.72	X
COL092		BN \$58.36	X
		RB \$58.36	X
		PN \$60.36	X
		MB \$56.36	X
		BBRZ \$60.85	X
		BSB \$60.85	X

MUNICH	GTG Hinge - 135°	Finish	Price
MUN-335		CH \$70.88	X
COL345		BN \$72.96	X
		RB \$72.96	X
		PN \$75.94	X
		MB \$72.96	X
		BBRZ \$75.10	X
		BSB \$75.10	X

Adjustable Only

Seville - BEVELED Edge - Extra Heavy Duty

SEVILLE	Wall Hinge - H Back Plate	Finish	Stock
SEV-110F		CH \$63.10	X
PLY037		BN \$64.86	X
		RB \$64.86	X
		PN \$67.50	
		MB \$64.86	X
		BBRZ \$68.24	X
		BSB \$68.24	X

Pricing is subject to change without notice.

Munich - BEVELED Edge - Adjustable Heavy Duty

MUNICH	Wall Hinge - H Back Plate	Finish	Stock
MUN-310H		CH \$48.28	X
COL337		BN \$49.38	X
		RB \$49.38	X
		PN \$51.22	X
		MB \$49.38	X
		BBRZ \$53.10	X
		BSB \$53.10	X

MUNICH	GTG Hinge - Offset Back Plate	Finish	Stock
MUN-310T		CH \$49.28	X
COL344		BN \$50.38	X
		RB \$50.38	X
		PN \$52.22	X
		MB \$50.38	X
		BBRZ \$54.10	X
		BSB \$54.10	X

MUNICH	GTG Hinge - Short Back Plate	Finish	Stock
MUN-310S		CH \$49.28	X
		BN \$50.38	X
		RB \$50.38	X
		PN \$52.22	X
		MB \$50.38	X
		BBRZ \$54.10	X
		BSB \$54.10	X

MUNICH	GTG Hinge - 180°	Finish	Stock
MUN-380		CH \$67.50	X
COL380		BN \$69.62	X
		RB \$69.62	X
		PN \$71.54	X
		MB \$69.62	X
		BBRZ \$74.05	X
		BSB \$74.05	X

MUNICH	GTG Hinge - 135°	Finish	Price
MUN-335		CH \$70.88	X
COL345		BN \$72.96	X
		RB \$72.96	X
		PN \$75.94	X
		MB \$72.96	X
		BBRZ \$75.10	X
		BSB \$75.10	X

Pricing is subject to change without notice.

Dublin - BEVELED Edge Pivot Hinge

DUBLIN	Pivot Hinge - Top or Bottom	Finish	Stock
DUB-110F		CH \$30.50	X
PPH01		BN \$31.20	X
		RB \$33.88	X
		PN \$33.40	X
		MB \$31.20	X
		BBRZ \$36.70	X
		BSB \$36.70	X

DUBLIN	Pivot GTG - Transom	Finish	Stock
DUB-180		CH \$58.40	X
PPH02		BN \$59.62	X
		RB \$59.62	X
		PN \$60.80	X
		MB \$59.52	X
		BBRZ \$62.10	X
		BSB \$62.10	X

DUBLIN	Mount Hinge	Finish	Stock
DUB-110T		CH \$42.50	X
PPH05L		BN \$43.20	X
PPH05R		RB \$45.88	X
		PN \$45.40	X
		MB \$45.20	X
		BBRZ \$48.70	X
		BSB \$48.70	X

DUBLIN	Wall Mount Hinge Bracket	Finish	Stock
DUB-110L		CH \$42.50	X
PPHO3		BN \$43.20	X
		RB \$45.88	X
		PN \$45.40	X
		MB \$43.20	X
		BBRZ \$48.70	X
		BSB \$48.70	X

DUBLIN	Pivot Hinge - Mont	Finish	Stock
DUB301F		CH \$42.30	X
PPH301		BN \$43.10	X
		RB \$43.10	X
		PN \$45.12	X
		MB \$43.10	X
		BBRZ \$46.80	X
		BSB \$46.80	X

	Pivot Adaptor Block	Finish	Stock
PAB-10		CH \$8.10	X
HAB01		BN \$8.61	X
		RB \$8.61	X
		PN \$8.94	X
		MB \$8.61	X
		BBRZ \$9.28	X
		BSB \$9.28	X

DUBLIN	Pivot Hinge with Attached Clamp	Finish	Stock
DUB-710		CH \$42.56	X
PPH07		BN \$43.65	X
		RB \$43.65	X
		PN \$45.12	X
		MB \$43.65	X
		BBRZ \$46.65	X
		BSB \$46.64	X

Pricing is subject to change without notice.

Windsor - STRAIGHT Edge Pivot Hinge

WINDSOR	Pivot Hinge - Top or Bottom	Finish	Price
WIN110F CAR01		CH	\$32.50 X
		BN	\$33.20 X
		RB	\$35.88 X
		PN	\$35.40 X
		MB	\$33.20 X
		BBRZ	\$38.70 X
		BSB	\$58.10 X

WINDSOR	Pivot GTG - Transom	Finish	Price
WIN-180 CAR02		CH	\$0.40 X
		BN	\$61.62 X
		RB	\$61.62 X
		PN	\$62.80 X
		MB	\$61.52 X
		BBRZ	\$64.10 X
	BSB	\$64.10 X	

WINDSOR	Off Set Plate (L or R)	Finish	Price
WIN-110T CAR05L CAR05R		CH	\$44.50 X
		BN	\$45.20 X
		RB	\$47.88 X
		PN	\$48.40 X
		MB	\$45.20 X
		BBRZ	\$50.70 X
		BSB	\$50.70 X

WINDSOR	Pivot Hinge - Top or Bottom	Finish	Price
WIN-110L CAR03		CH	\$44.30 X
		BN	\$45.20 X
		RB	\$47.88 X
		PN	\$48.40 X
		MB	\$45.20 X
		BBRZ	\$50.70 X
		BSB	\$50.77 X









Waterford - BEVELDED Edge - Heavy Duty Pivot Hinge

WATERFORD	Pivot Hinge - Top or Bottom	Finish	Stock
WAT-110F SRPP01		CH	\$57.40 X
		BN	\$58.60 X
		RB	\$58.60 X
		PN	\$59.20 X
		MB	\$58.60 X
		BBRZ	\$62.80 X
		BSB	\$62.80 X

WATERFORD	Pivot Adaptor Block	Finish	
HDPAB-10 SRMHAB01		CH	\$14.10 X
		BN	\$14.80 X
		RB	\$14.80 X
		PN	\$15.20 X
		MB	\$14.90 X
		BBRZ	\$16.44 X
	BSB	\$16.44 X	

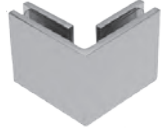



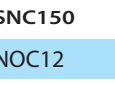



Pricing is subject to change without notice.

STRAIGHT Edge Clamps

Wall - Single Hole/ Finger Notch		Finish	Stock	Wall - Two Hole/Finger Notch		Finish	Stock
SC-150		CH \$7.25	X	SC-155		CH \$7.64	X
SCU4		BN \$7.54	X	SGCU1		BN \$7.94	X
		RB \$7.73	X			RB \$8.14	X
		PN \$8.11	X			PN \$7.54	
		MB \$7.54	X			MB \$7.94	X
		BBRZ \$8.11	X			BBRZ \$8.54	
		BSB \$8.11	X			BSB \$8.54	
Glass to Wall 90°		Finish	Stock	Glass to Glass - 135° Closed End		Finish	Stock
SC-190		CH \$12.78	X	SC-135		CH \$18.37	X
SGC039		BN \$13.34	X	SGC135		BN \$18.72	X
		RB \$13.94	X			RB \$19.07	X
		PN \$13.94	X			PN \$19.07	X
		MB \$13.34	X			MB \$18.72	X
		BBRZ \$14.33	X			BBRZ \$21.36	X
		BSB \$14.33	X			BSB \$21.36	X
Glass to Glass - 90° Closed End		Finish	Stock	Glass to Wall Bracket		Finish	Stock
SC-195		CH \$18.16	X	HSC-190		CH \$29.46	X
SGC90		BN \$18.52	X	GE90S		BN \$28.75	X
		RB \$18.86	X			RB \$29.90	X
		PN \$18.86	X			PN \$29.90	X
		MB \$18.52	X			MB \$28.75	X
		BBRZ \$20.62	X			BBRZ \$34.10	X
		BSB \$20.62	X			BSB \$34.10	X
Movable Transom - Wall		Finish	Stock	Movable Transom - GTG		Finish	Stock
SC-185		CH \$8.50	X	SC-160		CH \$14.30	X
SGC186		BN \$8.79	X	SGC188		BN \$14.10	X
		RB \$8.98	X			RB \$14.90	X
		PN \$8.98	X			PN \$14.90	X
		MB \$8.79	X			MB \$14.10	X
		BBRZ \$9.36	X			BBRZ \$15.80	X
		BSB \$9.36	X			BSB \$15.80	X
Stationary 180° - GTG		Finish	Stock	Notohless Clamp		Finish	Stock
SC-165		CH \$15.30	X	SNC150		CH \$7.29	X
SGCXXX		BN \$15.10	X	NOC12		BN \$7.09	X
		RB \$15.90	X			RB \$7.39	X
		PN \$15.90				PN \$7.39	X
		MB \$15.10	X			MB \$7.09	X
		BBRZ \$16.80	X			BBRZ \$9.80	X
		BSB \$16.80	X			BSB \$9.80	X

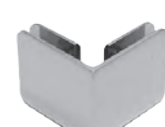
Pricing is subject to change without notice.

BEVELED Edge Clamps

Wall - Single Hole/ Finger Notch		Finish	Stock	Wall - Two Hole/ Finger Notch		Finish	Stock
BC-150		CH \$7.98	X	BC-155		CH \$8.14	X
BCU4		BN \$8.08	X	BGCU2		BN \$8.44	X
		RB \$8.49	X			RB \$8.64	X
		PN \$8.49	X			PN \$8.94	
		MB \$8.08	X			MB \$8.44	X
		BBRZ \$8.98	X			BBRZ \$9.94	
		BSB \$8.98	X			BSB \$8.94	
Glass to Wall 90°		Finish	Stock	Glass to Glass - 135° Closed End		Finish	Stock
BC-190		CH \$14.67	X	BC-135		CH \$19.36	X
BGC039		BN \$15.15	X	BGC135		BN \$21.12	X
		RB \$15.85	X			RB \$21.52	X
		PN \$15.85	X			PN \$21.52	X
		MB \$15.15	X			MB \$21.12	X
		BBRZ \$16.10	X			BBRZ \$22.80	X
		BSB \$16.10	X			BSB \$22.80	X
Glass to Glass - 90° Closed End		Finish	Stock	Glass to Wall Bracket		Finish	Stock
BC-195		CH \$18.62	X	HBC-190		CH \$30.10	X
BGC90		BN \$19.36	X	PIN90S		BN \$30.62	X
		RB \$19.56	X			RB \$30.94	X
		PN \$19.56	X			PN \$30.94	X
		MB \$19.36	X			MB \$30.62	X
		BBRZ \$21.21	X			BBRZ \$34.80	X
		BSB \$21.21	X			BSB \$34.80	X
Movable Transom - Wall		Finish	Stock	Movable Transom - GTG		Finish	Stock
BC-185		CH \$9.00	X	BC-160		CH \$14.80	X
BGC186		BN \$9.29	X	BGC188		BN \$14.60	X
		RB \$9.48	X			RB \$15.40	X
		PN \$9.48	X			PN \$15.40	X
		MB \$9.39	X			MB \$14.60	X
		BBRZ	X			BBRZ \$16.30	X
		BSB	X			BSB \$16.30	X
Stationary 180° - GTG		Finish	Stock				
BC-165		CH \$15.80	X				
BGC180		BN \$15.60	X				
		RB \$16.40	X				
		PN \$16.40	X				
		MB \$15.60	X				
		BBRZ \$17.30	X				
	BSB \$17.30	X					

Pricing is subject to change without notice.

Back-to-Back D-Pull - 6" and 8"

EURO	Back-to-Back D-Pull - 6"	Finish	Stock
EH-6X6		CH \$13.74	X
BMNW6X6		BN \$13.10	X
		RB \$14.40	X
		PN \$14.40	X
		MB \$14.10	X

EURO	Back-to-Back D-Pull - 8"	Finish	Stock
EH-8X8		CH \$17.14	X
BMNW8X8		BN \$16.18	X
		RB \$17.30	X
		PN \$17.30	X
		MB \$16.80	X

EURO	Back-to-Back w/ Washers - 6"	Finish	Stock
EHW-6X6		CH \$17.45	X
BM6X6		BN \$16.80	X
		RB \$18.47	X
		PN \$18.47	X
		MB \$17.80	X
		BBRZ \$17.95	X
	BSB \$17.95	X	

EURO	Back-to-Back w/ Washers - 8"	Finish	Stock
EHW-8X8		CH \$19.10	X
BM8X8		BN \$18.15	X
		RB \$21.50	X
		PN \$21.50	X
		MB \$20.90	X
		BBRZ \$21.90	X
	BSB \$21.90	X	

SQUARE	Ladder Back-to-Back - 6"	Finish	Stock
LH-6X6		CH \$36.36	X
LP6X6		BN \$35.10	X
		RB \$37.80	X
		PN \$37.80	X
		MB \$36.36	X
		BBRZ \$41.20	X
	BSB \$41.20	X	

SQUARE	Ladder Back-to-Back - 8"	Finish	Stock
LH-8X8		CH \$38.68	X
LP8X8		BN \$37.10	X
		RB \$39.80	X
		PN \$39.80	X
		MB \$38.68	X
		BBRZ \$43.20	X
	BSB \$43.20	X	

SQUARE	Square Back-to-Back - 6"	Finish	Stock
SH-6X6		CH \$29.62	X
SQ6X6		BN \$29.50	X
		RB \$31.80	X
		PN \$31.80	X
		MB \$29.62	X
		BBRZ \$33.10	X
	BSB \$30.10	X	

SQUARE	Square Back-to-Back - 8"	Finish	Stock
SH-8X8		CH \$32.62	X
SQ8X8		BN \$32.50	X
		RB \$33.80	X
		PN \$33.80	X
		MB \$32.62	X
		BBRZ \$35.10	X
	BSB \$35.10	X	

MITER	Mitered Back-to-Back - 6"	Finish	Stock
MHW-6X6		CH \$21.30	X
MT6X6		BN \$20.70	X
		RB \$22.05	X
		PN \$22.05	X
		MB \$20.70	X
		BBRZ \$23.05	X
	BSB \$23.05	X	

MITER	Mitered Back-to-Back - 8"	Finish	Stock
MHW-8X8		CH \$23.30	X
MT8X8		BN \$22.70	X
		RB \$24.05	X
		PN \$24.05	X
		MB \$22.70	X
		BBRZ \$25.05	X
	BSB \$25.05	X	

Pricing is subject to change without notice.

Heavy Glass Hardware

EURO	Single Mount 6"	Finish	Stock
EH-6		CH \$9.75	X
BPS6		BN \$9.75	X
		RB \$9.95	X
		PN \$9.95	X
		MB \$9.75	X
		BBRZ \$12.00	X
		BSB \$12.00	X

EURO	Single Mount 8"	Finish	Stock
EH-8		CH \$10.75	X
BPS8		BN \$10.75	X
		RB \$10.95	X
		PN \$10.95	X
		MB \$10.75	X
		BBRZ \$13.00	X
		BSB \$13.00	X

LADDER	Single Mount 6"	Finish	Stock
LH-6		CH \$22.10	X
XXXXX		BN \$21.70	X
		RB \$23.40	X
		PN \$23.40	X
		MB \$22.10	X
		BBRZ \$25.80	X
		BSB \$25.80	X

LADDER	Single Mount 8"	Finish	Stock
LH-8		CH \$24.10	X
XXXXX		BN \$23.70	X
		RB \$24.40	X
		PN \$24.40	X
		MB \$24.10	X
		BBRZ \$26.80	X
		BSB \$26.80	X

ROUND Pull Knob

	Single Mount	Finish	Stock
PK-20		CH \$5.80	X
SDK212		BN \$6.40	X
		RB \$6.90	X
		PN \$6.90	X
		MB \$6.40	X
		BBRZ \$7.10	X
		BSB \$7.10	X

	Single Mount w/ Bumper Sleeve	Finish	Stock
PK-30		CH \$6.80	X
SDKP212		BN \$7.40	X
		RB \$7.90	X
		PN \$7.90	X
		MB \$7.40	X
		BBRZ \$8.10	X
		BSB \$8.10	X

	Back-to-Back	Finish	Stock
PK-220		CH \$6.24	X
SDK112		BN \$6.70	X
		RB \$7.10	X
		PN \$7.10	X
		MB \$6.70	X
		BBRZ \$9.05	X
		BSB \$9.05	X

	Back-to-Back w/ Bumper Sleeve	Finish	Stock
PK-330		CH \$7.80	X
SDKP112		BN \$8.20	X
		RB \$8.60	X
		PN \$8.60	X
		MB \$8.20	X
		BBRZ \$9.40	X
		BSB \$9.40	X

Pricing is subject to change without notice.

TRADITIONAL Pull Knob

Single Mount	Finish	Stock
 PK-40 SDK200	CH \$8.76	X
	BN \$9.18	X
	RB \$9.60	X
	PN \$9.60	X
	MB \$9.18	X
	BBRZ \$9.40	X
	BSB \$9.40	X

Back-to-Back	Finish	Stock
 PK-440 SDK100	CH \$11.70	X
	BN \$12.05	X
	RB \$12.50	X
	PN \$12.50	X
	MB \$12.05	X
	BBRZ \$12.70	X
	BSB \$12.70	X

Robe Hook Thru Glass	Finish	Stock
 RHD - 1 DRH1	CH \$8.79	X
	BN \$8.36	X
	RB \$9.75	X
	PN \$9.75	X
	MB \$9.50	X
	BBRZ \$10.86	X
	BSB \$10.86	X

Bowtie Knob Back-to-Back	Finish	Stock
 PK-550 SDK109	CH \$14.61	X
	BN \$14.81	X
	RB \$14.91	X
	PN \$14.91	X
	MB \$14.61	X
	BBRZ \$15.36	X
	BSB \$15.36	X

TOWEL BAR

EURO	Euro Single Mount - 18"	Finish	Stock
ETB-18		CH \$13.74	X
BMNW18		BN \$14.24	X
		RB \$15.80	X
		PN \$15.80	X
		MB \$13.74	X
		BBRZ \$18.10	X
		BSB \$18.10	X

EURO	Back-to-Back Towel Bar - 18"	Finish	Stock
ETB-18X18		CH \$29.60	X
BMNW18X18		BN \$28.90	X
		RB \$30.90	X
		PN \$30.90	X
		MB \$29.60	X
		BBRZ \$36.60	X
		BSB \$36.60	X

EURO	Euro Single Mount - 24"	Finish	Stock
ETB-24		CH \$16.40	X
BMNW24		BN \$16.80	X
		RB \$17.80	X
		PN \$17.80	X
		MB \$16.40	X
		BBRZ \$19.10	X
		BSB \$19.1	X

EURO	Back-to-Back Towel Bar - 24"	Finish	Stock
ETB-24X24		CH \$32.60	X
BMNW24X24		BN \$31.90	X
		RB \$33.90	X
		PN \$33.90	X
		MB \$32.60	X
		BBRZ \$39.60	X
		BSB \$39.60	X

SQUARE	Square Towel Bar - 18"	Finish	Stock
STB-18		CH \$34.42	X
SQ18		BN \$31.35	X
		RB \$36.30	X
		PN \$36.30	X
		MB \$31.35	X
		BBRZ \$36.20	X
		BSB \$36.20	X

SQUARE	Square Towel Bar - 24"	Finish	Stock
STB-24		CH \$37.02	X
SQ24		BN \$37.35	X
		RB \$39.10	X
		PN \$39.10	X
		MB \$37.02	X
		BBRZ \$38.20	X
		BSB \$38.20	X

EURO	Combo - 6"x18"	Finish	Stock
ECB-6X18		CH \$25.78	X
BMNW6X18		BN \$25.15	X
		RB \$27.80	X
		PN \$27.80	X
		MB \$25.78	X
		BBRZ \$28.15	X
		BSB \$28.15	X



EURO	Combo - 8"x18"	Finish	Stock
ECB-8X18		CH \$28.78	X
BMNW8X18		BN \$29.15	X
		RB \$31.80	X
		PN \$31.80	X
		MB \$29.78	X
		BBRZ \$33.15	X
		BSB \$33.15	X



EURO	Combo - 6"x24"	Finish	Stock
ECB-6X24		CH \$29.78	X
BMNW6X24		BN \$29.15	X
		RB \$32.80	X
		PN \$32.80	X
		MB \$29.78	X
		BBRZ \$33.15	X
		BSB \$33.15	X

EURO	Combo - 8"x24"	Finish	Stock
ECB-8X24		CH \$33.78	X
BMNW8X24		BN \$33.15	X
		RB \$36.80	X
		PN \$36.80	X
		MB \$33.78	X
		BBRZ \$37.15	X
		BSB \$37.15	X

Pricing is subject to change without notice.



CLAMPS



Glass-to-Glass Sleeve Over - 90°		Finish	Stock	Glass-to-Glass Sleeve Over - 135°		Finish	Stock
SO-90		CH \$11.65	X	SO-135		CH \$13.10	X
SOGC90		BN \$11.95	X	SOGC135		BN \$13.50	X
		RB \$12.37	X			RB \$14.30	X
		PN \$12.37	X			PN \$14.30	X
		MB \$11.95	X			MB \$13.50	X
		BBRZ \$12.98	X			BBRZ \$14.90	X
		BSB \$12.98	X			BSB \$14.90	X

Glass-to-Glass Sleeve Over - Left		Finish	Stock	Glass-to-Glass Sleeve Over - Right		Finish	Stock
SO-180L		CH \$7.00	X	SO-180R		CH \$7.00	X
SOGC37L		BN \$7.40	X	SOGC37R		BN \$7.40	X
		RB \$8.05	X			RB \$8.05	X
		PN \$8.05	X			PN \$8.05	X
		MB \$7.40	X			MB \$7.40	X
		BBRZ \$8.80	X			BBRZ \$8.80	X
		BSB \$8.80	X			BSB \$8.80	X

Glass-to-Glass Sleeve Over - Adjustable		Finish	Stock
SO-ADJ		CH \$18.75	X
SOGC91		BN \$20.02	X
		RB \$21.40	X
		PN \$21.40	X
		MB \$20.02	X
		BBRZ \$22.24	X
		BSB \$22.24	X

BRACKETS

ELITE	Adjustable Header Bracket	Finish	Stock	ELITE	Header Bracket - 90°	Finish	Stock
EHB-B00		\$8.00	X	EHB-90		\$7.50	X
BHC373		No Color		BHC90		No Color	

ELITE	Header Bracket - 135°	Finish	Stock	ELITE	Header Bracket - 180°	Finish	Stock
EHB-135		\$7.50	X	EHB-180		\$4.36	X
BHC135		No Color		BWB2		No Color	

Pricing is subject to change without notice.

VINYL

VINYL	890 Header Vinyl - 3/8"	Finish	Stock
VM-45		CL \$0.42	X
HV380			

VINYL	Bubble - 5/32" with Tape 98"	Finish	Stock
VM-42T		CL \$1.04	X
SDTJ			

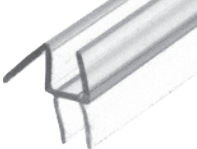
VINYL	Splash Plate - 3/8" - 30"	Finish	Stock
VM-40-30		CL \$4.80	X
P990WS		BL \$5.10	X

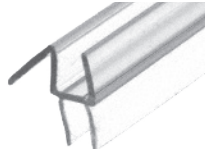
VINYL	Splash Plate - 3/8" - 98"	Finish	Stock
VM-40-96		CL \$7.82	X
P990WS-96		BL \$9.12	X

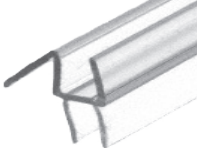
VINYL	Splash Plate - 1/2" - 30"	Finish	Stock
VM-44		CL \$9.12	X
P912WS			

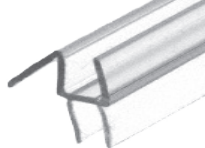
VINYL	Splash Plate - 1/2" - 98"	Finish	Stock
VM-44-98		CL \$8.40	X
P912WS-96			

VINYL	Bubble Vinyl Adhesive Tape	Finish	Stock
N/A		CL \$8.10	X
AT0201436			

VINYL	Clear H Wipe - 98"	Finish	Stock
VM-38		CL \$6.08	X
P375 HWS			

VINYL	Clear Cynyl Overlap Seal - 98' Finish	Stock	
VM-50		CL \$13.24	X
PCSER78			

VINYL	Clear Bumper Vinyl - 98"	Finish	Stock
VM-49		CL \$10.72	X
PCR10			

VINYL	Bottom Sweep - Gemni	Finish	Stock
VM-40		CL \$3.68	X
P995WS			

VINYL	Clear Strike Jamb - 98"	Finish	Stock
VM-46-47		CL \$11.04	X
P180 SDJ			

Pricing is subject to change without notice.

MISCELLANEOUS Parts and Price Lengths

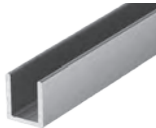
UCHANNEL 3/8" - 124" Length	Finish	Stock
892 SDCD38-96 	CH \$18.63	X
	BN \$19.88	X
	RB \$15.07	X
	PN \$26.94	X
	MB \$15.07	X
	BBRZ \$22.38	X
	BSB \$25.94	X

UCHANNEL 1/2" - 124" Length	Finish	Stock
893 SDCD12-96 	CH \$19.89	X
	BN \$19.98	X
	RB \$17.41	X
	PN \$27.40	
	MB \$17.41	X
	BBRZ \$22.82	X
BSB \$26.98		

HEADER For Pivot Hinges - 124"	Finish	Stock
890 SDH980-96 	CH \$79.59	X
	BN \$83.80	X
	RB \$70.88	X
	PN \$94.40	X
	MB \$70.88	X
	BBRZ \$88.40	X
	BSB \$94.60	X

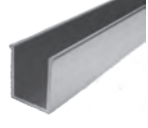
HEADER Snap Filler - 124"	Finish	Stock
894 S1F720 	CH \$18.70	X
	BN \$19.20	X
	RB \$16.88	X
	PN \$19.80	
	MB \$16.80	X
	BBRZ \$22.40	
BSB \$23.80		

Damstrip - 98"	Finish	Stock
897 SDT980 	CH \$18.19	X
	BN \$23.10	X
	RB \$17.59	X
	PN	
	MB \$17.59	X
	BBRZ	
	BSB	

Damstrip - 98" Clear	Finish	Stock
898 	CL \$9.88	X

Grid Rails - 98"	Finish	Stock
899 VFT75MBL 	MB \$25.76	X

Pricing is subject to change without notice.

Barn-Style Slider Series

Atlantis - 3/8" Glass		Finish	Stock
	CH	\$294	X
	BN	\$294	X
	MB	\$322	X

Barcelona 3/8" Glass		Finish	Stock
	CH	\$210	X
	BN	\$200	X
	MB	\$238	X



Galileo - 3/8" Glass		Finish	Stock
	CH	\$310	X
	BBRZ	\$374	X
	BN	\$290	X
	BSB	\$377	X
	MB	\$322	X



Gemini - 3/8" Glass		Finish	Stock
	CH	\$405	X
	BBRZ	\$485	X
	BN	\$395	X
	BSB	\$485	X
	MB	\$425	X



Madrid - 1/4" Glass		Finish	Stock
	CH	\$234	X
	BN	\$240	X
	MB	\$256	X



Pricing is subject to change without notice.



Lagos - COMMERCIAL - Barn Door Style

Top Sliding Wall Mount Clamps		Finish	Stock	Anti Left Top Roller		Finish	Stock
LAGWM		BS \$10.20	X	LAGROLL		BS \$88.40	X
LS402		CH \$11.16	X	LS400		CH \$89.10	X
		MB \$11.16	X			MB \$89.10	X

Adjustable Floor Guide		Finish	Stock	Left Hand Door Stop		Finish	Stock
LAGGUIDE		BS \$6.80	X	LAFDSL		BS \$12.05	X
LS307		CH \$7.12	X	LS405L		CH \$12.80	X
		MB \$7.12	X			MB \$12.80	X

Righ Hand Door Stop		Finish	Stock	Floor Mount Stop		Finish	Stock
LAGDSR		BS \$12.05	X	LAGFSTOP		BS \$13.30	X
LS405R		CH \$12.80	X	LS407		CH \$14.05	X
		MB \$12.80	X			MB \$14.05	X



Top Sliding Glass Mount		Finish	Stock	Bar - 104"		Finish	Stock
LAGGMH		BS \$14.80	X	LAGBAR		BS \$88.45	X
LS403		CH \$15.65	X	LS104		CH \$89.70	X
		MB \$15.65	X			MB \$89.70	X

Tube Wall Mount End Bracket		Finish	Stock	Bar End Cap		Finish	Stock
GALBB		BS \$16.80	X	LAGCAP		BS \$3.30	X
LS106		CH \$17.24	X	LS104CAP		CH \$3.50	X
		MB \$17.24	X			MB \$3.50	X

Puck Handle		Finish	Stock
PUCK02		BS \$16.80	X
SERNHP2		CH \$17.10	X
		MB \$17.10	X

Pricing is subject to change without notice.

COMMERCIAL- Parts

Glass Spigot - Compression		Finish	Stock	Ladder Handle 24" - 1 1/4" Dia		Finish	Stock
BWCC-CSM		BS \$81.34	X	CLP24		BS \$121.80	X
AFWC1		CH \$82.80	X	LP24		CH \$121.80	X
		MB \$81.34	X			MB \$128.50	X

Recessed Standoff - 2" Dia x 1 3/4"		Finish	Stock
RSO-200		BS \$52.10	X
RSOB2134		CH \$53.20	X
		MB \$61.53	X

Wind Screen - Glass to Glass 180°		Finish	Stock
WS-180		BS \$17.05	X
GBC180		CH \$18.30	X
		MB \$19.40	X

Wind Screen - Glass to Wall		Finish	Stock
WS-900		BS \$16.12	X
GBC90		CH \$17.40	X
		MB \$17.80	X

Wind Screen - Glass to Glass 90°		Finish	Stock
WS-190		BS \$19.05	X
GBCWM		CH \$21.10	X
		MB \$22.80	X