



















Parts

ITEM	PART #	QTY	DESCRIPTION		ITEM	PART #	QTY	DESCRIPTION	
A	802	1	Stay Clean Sill		K	816	1	Towel Bar	
B	814	2	Wall Jamba		L	151	1	Bottom Guide	
C	113	6	Plastic Wall Anchors		M	119	3	#6 X 1/2" Pan Head Screws	
D	110	6	#8 x 1 1/2" Pan Head Screw		N	120	2	#10-24 x 3/8" Phillips Flat Head	
E	825	1	Tub Header		O	158	2	Towel Bar Trim Rings	
F		2	Glass Panel		P	138	2	Towel Bar Brackets	
G	131	4	Vinyl Jamb Bumpers		Q	836	2	Towel Bar Bases	
H	115	4	#6 x 3/4" Pan Head Screws		R	VM-18	3	Clamp On Vinyl (1 1/2")	
I	116	4	#6 x 32-3/8" Hex Head Screws		S	837	1	Clamp On Handle	
J	130	4	Roller Bearing						

Tools



Hacksaw



Philips Screwdriver



Level



#32 and 3/16" Drill Bit



Drill

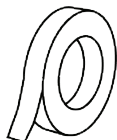

Masking Tape



Safety Glasses



Tape Measure



Silicone



Mallet

Installation Notes

- Unpack your unit carefully. Lay out and identify all parts using the instruction sheets as a reference. Before discarding the carton, check for any small hardware bags.
- If any parts are damaged or missing, refer to the description noted in the instructions when contacting your dealer for replacements.
- Please wear safety glasses whenever drilling or cutting.
- Handle the glazed panels carefully; tempered glass is difficult to break, but the sharp corners of the panels can damage tile and floor coverings.
- Before installing, check the tub rim for level and both walls for plumb. If either are out of plumb more than 3/8", you may want to contact your dealer for tapered fillers which can be used to level tub track or plum the side jambs.



Caution: Tempered glass cannot be cut or drilled

1.

SETTING the TUB TRACK with VINYL

Step 1a.

- Measure from wall-to-wall, 1/2" above the sill and cut the stay clean sill (A) 1/16" short of these dimensions.

1a

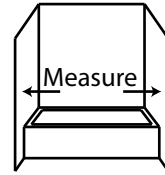

Step 1b.

- Position the stay clean sill (A) in the center of the tub rim with the tall leg facing the exterior. It may be necessary to file a radius on the ends of the tub track and wall jambs to match the corners of the tub.

1b

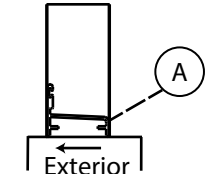

Step 1c.

- Press both wall jambs (B) into position over the tub track. Masking tape can be used to temporarily hold parts in place.

1c

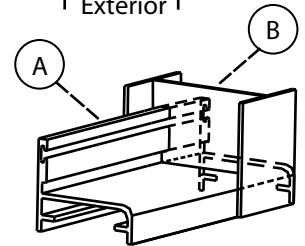

2.

MARKING for WALL JAMB

Step 2a.

- Use a level to plumb both wall jambs (B), then mark the pre-drilled hole locations on the wall. You can use a center punch or pencil.
- Lightly mark along both sides of the stay clean sill (A) with a pencil. Remove all parts and drill the walls using a 3/16" drill bit (for tile or marble use 3/16" masonry bit). Insert wall anchors (C) into holes.

2a

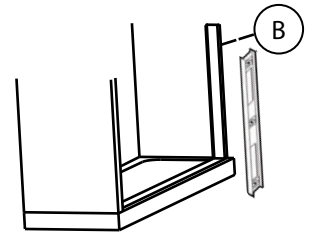

Note: Attachments to fiberglass or acrylic can be made in two ways: if reinforcement is built into the wall of the unit, drill six (3 per wall jamb) 1/8" diameter holes and install the screws directly into the reinforcement.

If wall is not reinforced, drill 3/16" holes and install plastic wall anchors (C).

3.

SECURING the TUB TRACK

Step 3a.

- Before replacing the stay clean sill (A), force a slight downward bow in the middle of extrusion. This will ensure that the track fits tight to the tub.
- Run two beads of silicone inside the penciled mark on the tub rim. Place the stay clean sill in the exact position you marked in step 2a and set it firmly in the silicone.
- Silicone the end where stay clean sill (A) meets the wall.
- Replace wall jamb (B) and attach to wall with #8 X 1 1/2" screws (D). Do not over tighten jamb screws.

3a

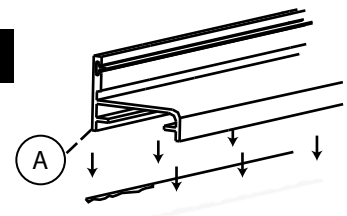

Place silicone along previously pencil marked tub rim

4.

FITTING the TUB HEADER

Step 4a.

- Measure from wall-to-wall at top of the wall jambs, subtract 1/16" from this dimension and cut the tub header (E) to its finished length. Set the header in place over the top of the wall jambs (B).

4a

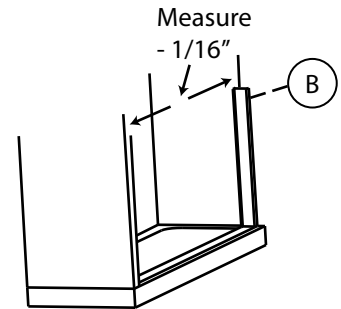

Step 4b.

- From the inside of the enclosure, drill one hole (#32 drill bit) through the header and the wall jamb on each end of the header.
- Attach the header to the tub jamb using two #6 X 1/2" screws (M).

4b

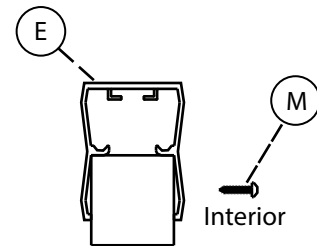

5.

INSTALL the GLASS PANELS

Step 5a.

- To install panels, attach the four nylon roller bearings (J) to the door panels using four #6-32 X 3/8" hex head screws (I) centered in the slots in the top fins. Patterned glass is always installed with the rough surface of the glass to the exterior of the unit.

5a

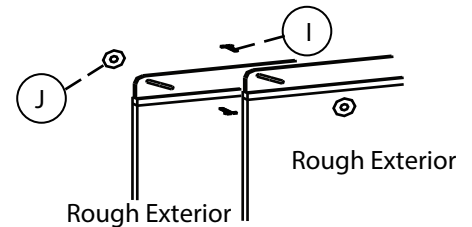

Step 5b.

- To set slider glass in place, hold interior panel inside of tub, insert rollers up into header and lower into roller track.

5b

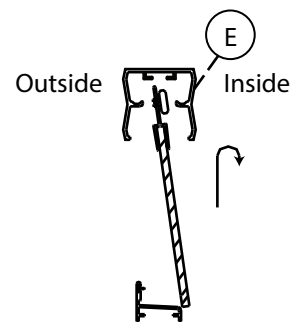

Step 5c.

- Next, insert lower end of exterior slider panel in front of interior slider panel by pushing lower ends far enough in to allow clearance on inside edge of tub. Avoid roller-to-roller contact while lifting panel into place.

5c

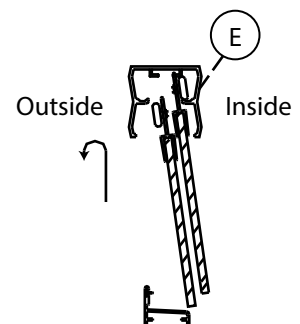

5.

INSTALL the GLASS PANELS CONTINUED

Step 5d.

- The interior panel should **always** be positioned closest to the showerhead for maximum waterproofing, as shown in illustration.

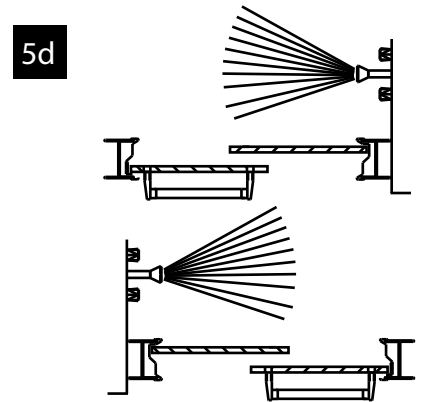

Step 5e.

- Next, push vinyl jamb bumpers (G) into side jambs (B) approximately 1" below center screw.
- Align the slot in the bumper with the outer rail of the slider panel and mark holes through the bumper and drill with #32 drill bit.
- Screw bumper in with #6 X 3/4" pan head screw (H). Repeat on other side.
Do not over tighten or rubber can tear rubber with movement.

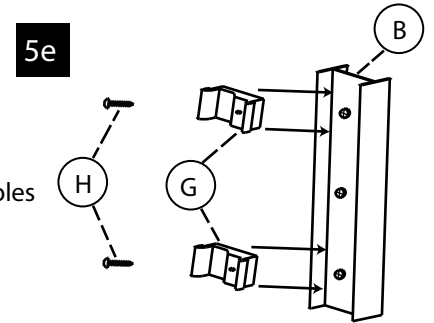

Step 5f.

- If the door panels are not parallel to their respective wall jambs, remove and adjust rollers up or down in their slots to compensate for out-of-plumb walls.

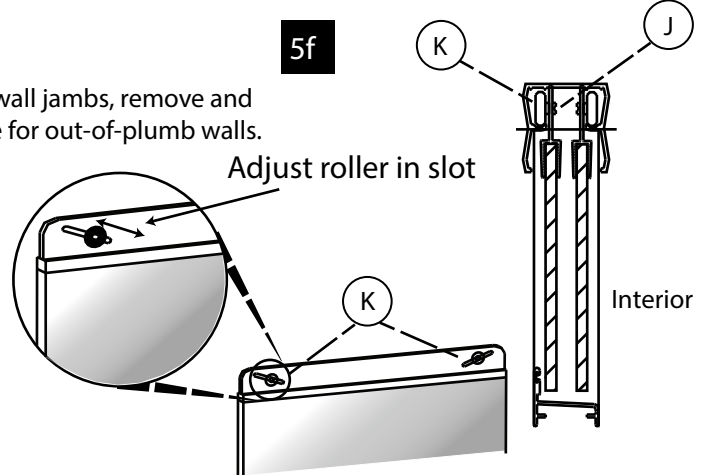

6.

CENTER GUIDE

Step 6a.

- Locate the nylon bottom guide (L) in the center of the stay clean sill (A) and place the center guide into place.
- Using the factory holes as a template, drill through hole into track with #32 drill bit.
- Attach center guide with #6 X 1/2" pan head screw (M).

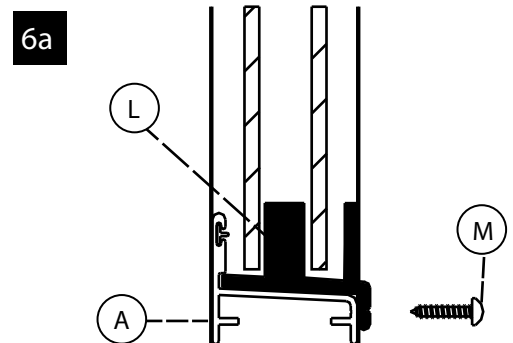

7.

TOWEL BAR and HANDLE

Step 7a.

- Slide the two towel bar trim rings (O) over the acrylic towel bar brackets (P) and attach to the towel bar bases (Q) with #10-24 X 3/8" phillips flat head screws (N).
- Force the towel bar (K) onto one of the brackets (P). At the center of the exterior glass panel, press the base (Q) (with towel bar attached) and vinyl (R) over the glass.
- Install the remaining base in a similar manner, locking the towel bar into place between the two brackets.

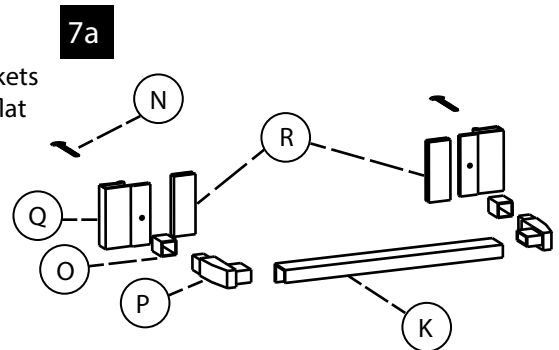

Step 7b.

- Press one clamp on handle (S) and vinyl (R) into place on the interior glass panel at the same height the towel bar bases (Q) were mounted on the exterior panel.
- See illustration in step 6b as reference to which panel the towel bar and handle is applied to.

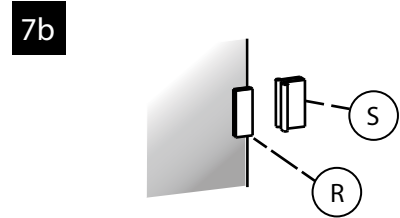

8.

ADDING SILICONE

Step 8a.

- Silicone each end of stay clean sill (A) where they meet the wall jambs (B). Run a bead of silicone along interior and exterior edge of stay clean sill and wall jambs.

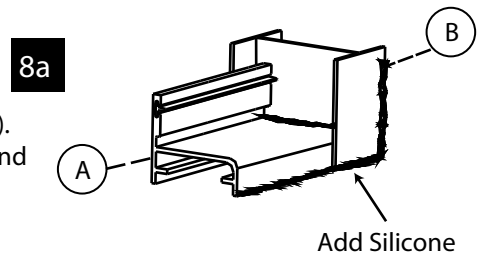

Step 8b.

- We recommend that you let the silicone dry for 24 hours before using the enclosure.

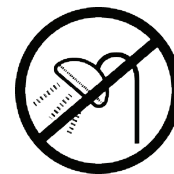

24hrs