





















### Parts

ITEM	PART #	QTY	DESCRIPTION		ITEM	PART #	QTY	DESCRIPTION	
A	420	2	Stall Curb		K	202	1	Latch Jamb with Magnet	
B	203	2	Wall Channel		L	119	12	#6 x 1/2" Pan Head Screws	
C	113	6	Plastic Wall Anchors		M	402	2	Curb Fillers	
D	110	6	#8 x 1 1/2" Pan Head Screw		N	122	8	#6 x 1/4" Philips Pan Type F	
E	147	1	Setting Block		O	145	2	90-Degree Bracket	
F		1	Glass Panel		P	VM-18	1	Handle Vinyl	
G	405	1	90-Degree Post		Q	VM-12	1	Frameless Drip Vinyl	
H	420	2	Stall Header		R	201	1	Hinge Jamb with Door Attached	
I	VM-4	4	Wall Channel Vinyl		S	262	1	Magnet Holder with Magnets	
J	VM-3	4	Stall Header and Curb Vinyl		T	EH6X6	1	Handle	

## Tools

---

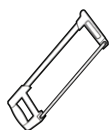

Hacksaw



Philips Screwdriver



Level



3/16" and 1/8" Drill Bit



Drill



Safety Glasses



Tape Measure



Masking Tape

## Installation Notes

---

- Unpack your unit carefully. Lay out and identify all parts using the instruction sheets as a reference. Before discarding the carton, check for any small hardware bags.
- If any parts are damaged or missing, refer to the description noted in the instructions when contacting your dealer for replacements.
- Please wear safety glasses whenever drilling or cutting.
- Handle the glazed panels carefully; tempered glass is difficult to break, but the sharp corners of the panels can damage tile and floor coverings.
- Before installing, check the tub rim for level and both walls for plumb. If either are out of plumb more than 3/8", you may want to contact your dealer for tapered fillers which can be used to level tub track or plumb the side jambs.



**Caution: Tempered glass cannot be cut or drilled**

# 1.

## STALL CURB and WALL CHANNEL

### Step 1a.

- Assemble the two curbs (A) by sliding a 90-degree bracket (O) into the miter ends of the stall curbs.
- Secure the 90-degree plate with four allen head #6 X 1/4" set screws (N). Do not over tighten the screws.
- Place the curb on center of sill with weep slots facing the inside of the shower and mark its position.

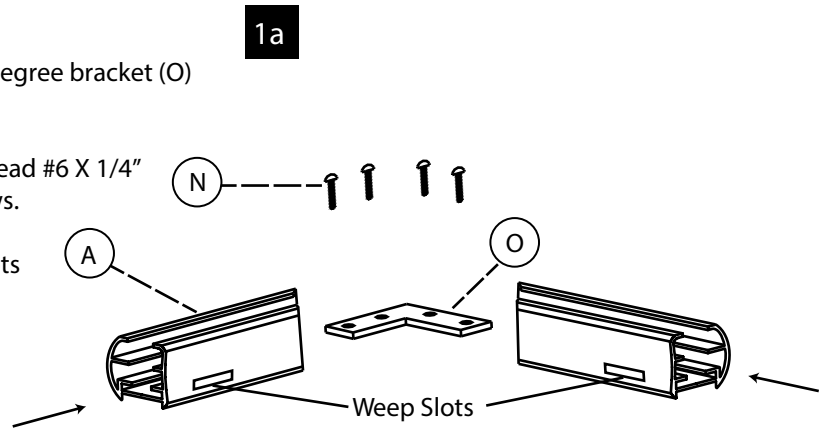

**Note:** In some instances, the ends of the curb section may have to be filed to fit the small radius at the ends of the base.

**Note:** The stall curb is cut to size at the factory. If not, measure stall curb from long point of miter, take centerline of curb and add 1/2". Measure stall curb from long point of miter

### Step 1b.

- Press the wall channels (B) into curb (A) with the open end facing out.

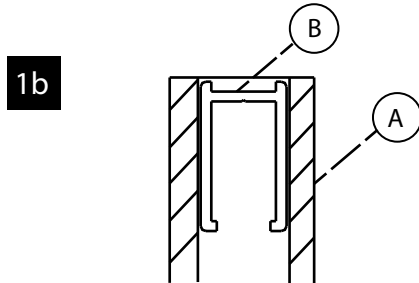

### Step 1c.

- Plumb the wall channels and mark the hole locations on the wall. Remove all parts and drill the walls with 3/16" drill bit (for tile, drill with a 3/16" masonry bit.)
- Insert plastic wall anchors (C) into drilled holes.
- Apply silicone to the underside of the curb (A) and replace in the exact position marked in step 1c.
- Caulk around both ends of the curb in the area where it meets the wall, around the 90-degree brackets (O), over screw heads, and the interior of the miter joints.

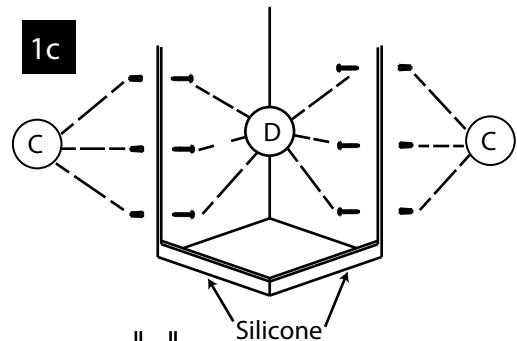

### Step 1d.

- Replace the wall channels (B) and secure to wall with six #8 X 1 1/2" pan head screws (D).

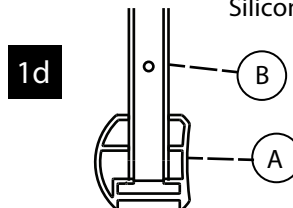

## 2.

### SETTING the GLASS PANELS

#### Step 2a.

- Place setting block (E) in the curbs (A) as shown. The setting block should be positioned to support glass panel (F) in the middle of panel.

**Note:** This illustration assumes the panel is on the left and the door is on the right. You have the option for having the door on the left or right.

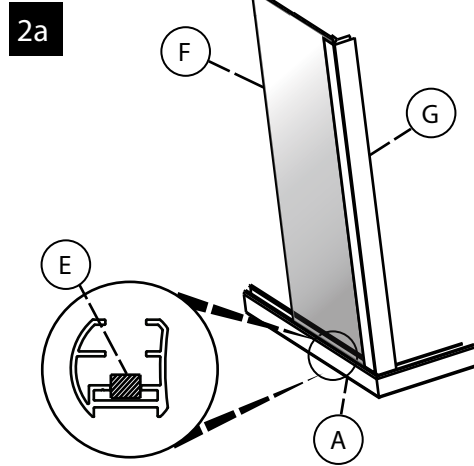

#### Step 2b.

- Set the glass panel so that it will rest on the setting block and will fit approximately 1/2" into the wall channel.
- If obscure glass is used, the rough surface must be turned to the exterior.
- Press the 90-degree post (G) into curb (A) and overlap glass panel (F) by 1/2".
- The 1/2" glass bite may be varied from 1/4" to 3/4" to facilitate out of plumb walls.

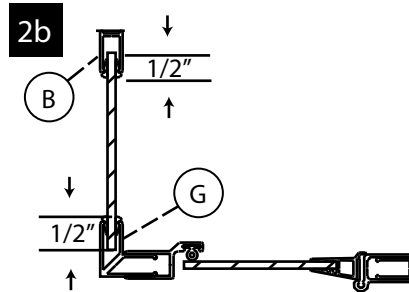

## 3.

### SECURING the HEADER

#### Step 3a.

- Plumb the 90-degree post (G) and measure the opening at the top of the wall channels (B) to the 90-degree post and add 1/4". Cut the header (H) to fit measurement. Do this for both ends.

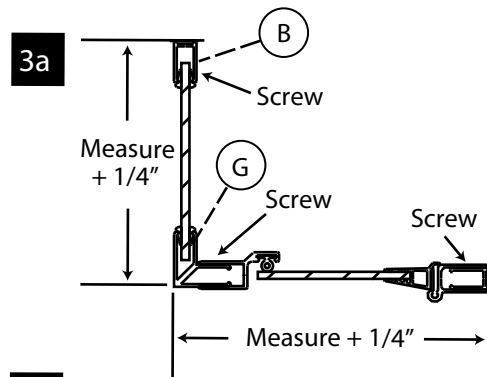

#### Step 3b.

- Assemble the two headers (H) by sliding the 90-degree bracket (O) into mitered ends of the header.
- Secure the 90-degree plate with four allen head #6 X 1/4" set screws (N). Do not over tighten.

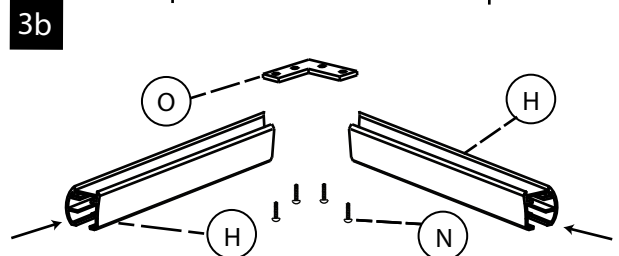

### 3.

#### SECURING the HEADER CONTINUED

##### Step 3c.

- Place header (H) over vertical posts; secure header to wall channels by drilling holes with a 1/8" drill bit through header & wall channels from inside of shower.
- Slide glass panel (F) away from the wall channels before drilling. The drill bit must not hit the glass.
- Secure with #6 X 1/2" pan head screws (L). Repeat on other side and bottom three corners.
- Reposition the glass panel.

3c

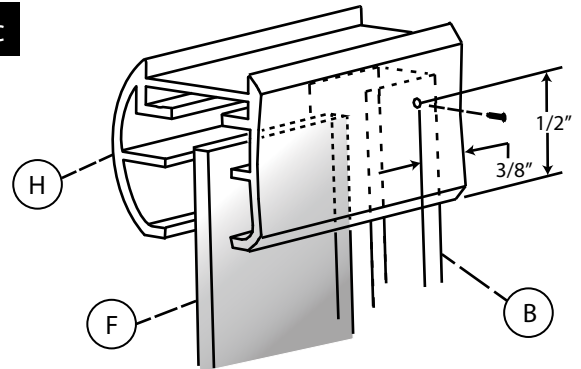

**Note:** Headers (H) come 3" longer to compensate for out of plumb walls. Make sure when cutting to size, you cut the sides of the headers that will be butting up to the wall, **NOT** mitered corners that meet and are secured by the 90-degree bracket (O).

### 4.

#### APPLYING the VINYL STRIPS

##### Step 4a.

- Inspect the glazing vinyl and note that there are two profiles. The larger profile (J) is installed horizontally and the smaller profile (I) is installed vertically. The horizontal vinyl is installed first.
- Cut the vinyl slightly longer than the opening (this prevents shrinkage). Press the interior vinyl into place.
- Use a wood block to tap the exterior vinyl into place starting at both ends and work towards the middle.
- Install the bottom vinyl in the same manner.
- Install the vertical vinyl being sure the corners fit tightly against the horizontal vinyl. If vinyl is difficult to tap on, lubricate the glass and vinyl with glass cleaner, then press on vinyl.

4a

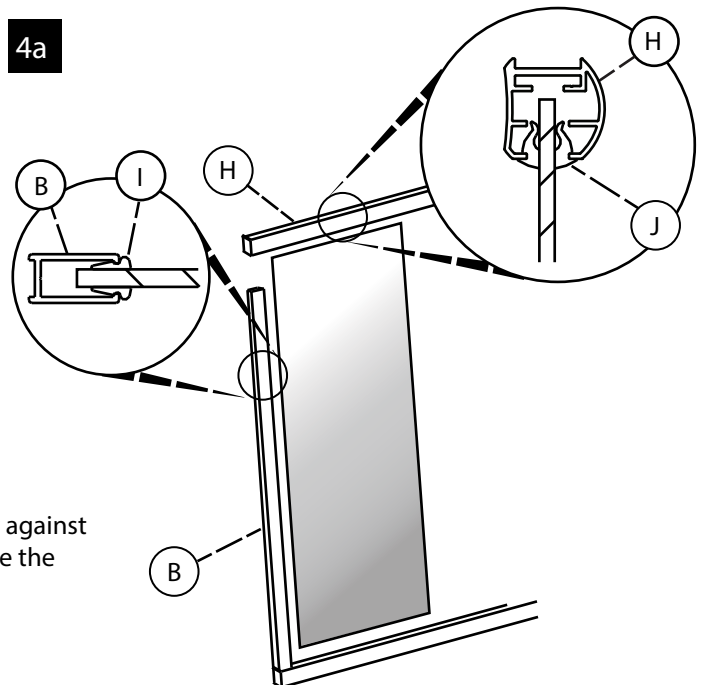

**Note:** The wall channel vinyl (I) may be provided with four strips in one. Tear each strip off.

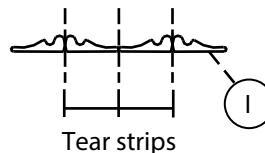

# 5.

## DOOR ADJUSTMENT

### Step 5a.

- The door is reversible and can swing to the right or left. Decide which way you wish the door to swing (illustration shows hinge right off wall).
- Slide latch jamb (K) over the appropriate post with the long side to the inside.
- Slide hinge jamb with door attached (R) over the appropriate post. The notch in the front of the hinge jamb at the top and bottom slides into curb fillers.
- Close the door so the magnets are touching. Move the door and make any adjustments on the 90-degree post and wall channel.
- Check gap above door so that it is even. Drill, with a #32 drill bit, to top pilot hole on hinge jamb and secure with #6 X 3/8" pan head screw (L); door will stay in place with one screw. Plumb the hinge and latch jambs, remaining five holes.

5a

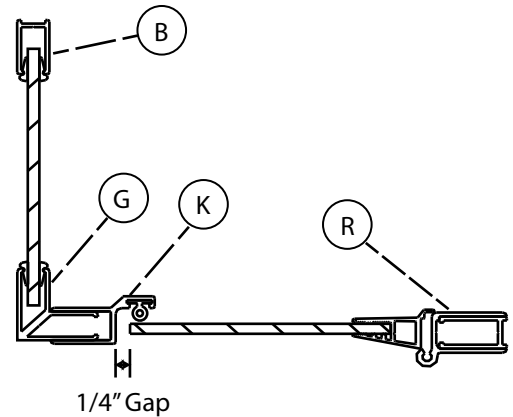

# 6.

## MEASURE for CURB FILLERS

### Step 6a.

- Measure between the 90-degree post (G) and the wall channel (B). Cut curb fillers (M) to this measurement.

6a

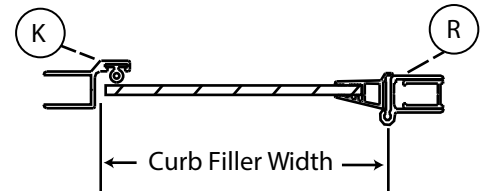

### Step 6b.

- Snap curb fillers into stall header (H) and stall curb (A) with the 1/8" lip to the outside.

6b

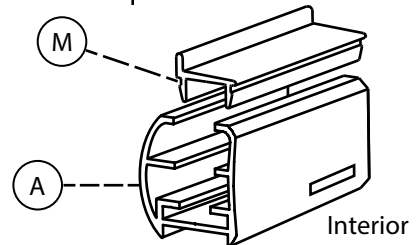

# 7.

## HANDLE ATTACHMENT

### Step 7a.

- The vinyl on the latch jamb has a notch; the magnet holder with magnet will be placed on glass and shut on notch.
- Wrap handle vinyl (P) around edge of glass, push magnet hold on vinyl. This goes on hard so there is no movement. May have to pound with mallet.
- Make sure the magnet catch on the magnet holder in on inside of the shower. Shut door to make sure magnets are touching.
- Add handle through holes in glass. Set screws should be on the inside.

7a

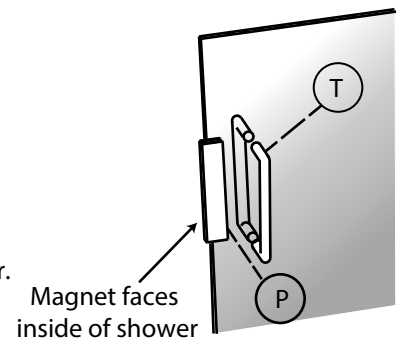

## 8.

### DRIP BAR

#### Step 8a.

- Take vinyl drip bar (Q). Note that there is a notch on both ends. Measure exposed glass at bottom of door. Cut vinyl 1/2" less than exposed glass.
- If door is hinge right, leave right side notch, opposite for a hinge left. Notch part of vinyl slides under rail that is attached to glass. Push up on glass, making sure lip on vinyl faces inside.

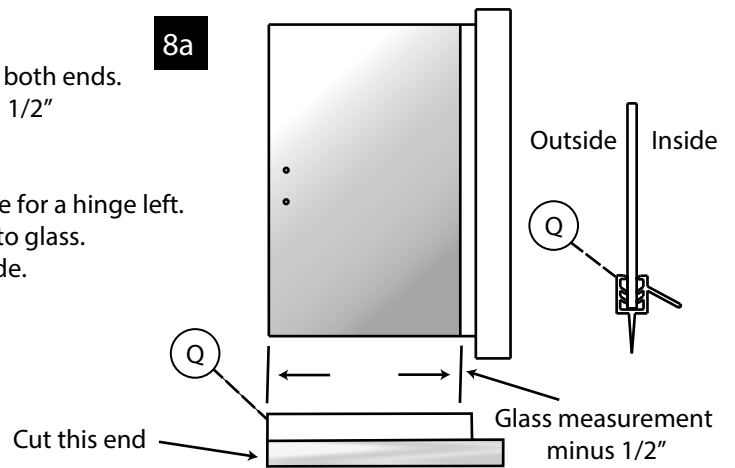

## 9.

### SILICONE SETUP

#### Step 9a.

- Silicone the entire unit where metal meets wall and curb. We recommend you let silicone set for 24 hours before using shower

