

### Parts

ITEM	PART #	QTY	DESCRIPTION	
A	201	1	Hinge Jamb with Door Attached	
B	202	2	Latch Jamb with Magnet and Bubble Vinyl	
C	203	2	Wall Channel	
D	110	6	#8 x 1 1/2" Pan Head Screw	
E	113	6	Plastic Wall Anchors	
F	119	6	#6 x 1/2" Pan Head Self Tapper	
G	261	1	Handle with Magnet	
H	VM-12	1	Vinyl Drip Bar	
I	209	1	Damstrip	
J	VM-18	1	Handle Vinyl	
K	182	2	Cap	

## Tools

---



Hacksaw



Philips Screwdriver



Level



#32 and 3/16" Drill Bit



Drill



Masking Tape



Straight Edge



Tape Measure



Silicone



Mallet



Safety Glasses

## Installation Notes

---

- Unpack your unit carefully. Lay out and identify all parts using the instruction sheets as a reference. Before discarding the carton, check for any small hardware bags.
- If any parts are damaged or missing, please contact the dealer you purchased from for replacements.
- Please wear safety glasses whenever drilling or cutting.
- Handle the glazed panels carefully; tempered glass is difficult to break, but the sharp corners of the panels can damage tile and floor coverings.
- Before installing, check the tub rim for level and both walls for plumb. If either are out of plumb more than 3/8", you may want to contact your dealer for tapered fillers which can be used to level tub track or plum the side jambs.



**Caution: Tempered glass cannot be cut or drilled**

# 1.

## DAMSTRIP and HINGE JAMB

### Step 1a.

- Cut the damstrip (I) to the wall-to-wall sill dimension and subtract 1/16".

1a

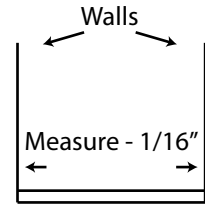

### Step 1b.

- Place it on the sill with the lip facing the exterior of the shower.
- The ends of the damstrip may have to be filed to fit the contour of the shower if installing on fiberglass.
- Use several pieces of masking tape to temporarily hold dam strip in place. Set damstrip onto sill, silicone each end for water protection.
- You will install the swing door on top of the dam strip (I) with the hinge jamb sliding into lip on damstrip.

1b

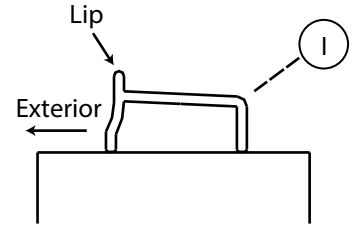

### Step 1c

- Determine the direction your door will swing and use a hacksaw to cut the hinge jamb (A) flush with the top end of the glass.
- Take the two wall channels (C) and the latch jamb (B) and cut them to the same length as the full hinge jamb (A).

1c

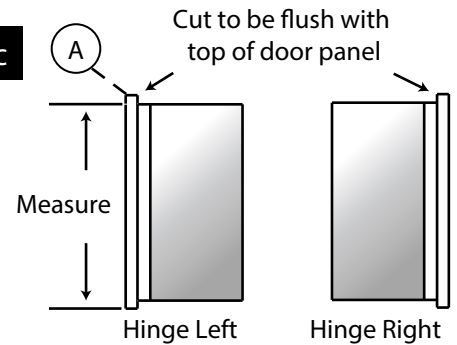

### Step 1d.

- Set the wall channels on the damstrip (I). Place a spacer (we suggest a nickel) 1/8" between the wall channels and the lip of the dam strip (I). This will become important later in the installation.
- Use a level to plumb the wall channels and use the factory pre-drilled holes as a template to mark the holes.
- Remove wall channels and drill the walls using a 3/16" drill bit (for tile or marble use 3/16" masonry bit).
- Insert wall anchors (E) into holes and secure to wall using #8 X 1 1/2" screws (D).

1d

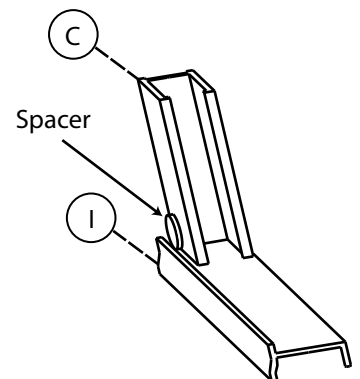

**Note:** Attachments to fiberglass or acrylic can be made in two ways: if reinforcement is built into the wall of the unit, drill six 1/8" diameter holes and install the screws directly into the reinforcement.

If wall is not reinforced, drill 3/16" holes and install plastic wall anchors (C).

# 1.

## DAMSTRIP and HINGE JAMB CONTINUED

### Step 1e.

- Set latch jamb (B) in place over the wall channel, but do not secure. From inside the shower, set the hinge jamb (A) (with door attached) in place over the wall channel (C).
- Close the door so the glass and vinyl on the latch jamb touch. Adjust door on wall channel so there is a 1/4" gap between glass edge and latch jamb.
- Next drill through the top pilot hole of the hinge jamb into wall channel using # 32 or 1/8" drill bit. Secure top hole using #6 X 1/2" screw (F). The door will be held in place with only the top screw.
- Plumb hinge jamb and secure the center and bottom holes.

**Note:** Door is adjustable up to 1" (1/2" at hinge jamb and 1/2" at latch). For example: A 2000-24 door will fit an opening 24"-25". For an opening of 24 1/4", this adjustment will be achieved by taking the hinge and latch jamb and adjusting it outward 1/8" each.

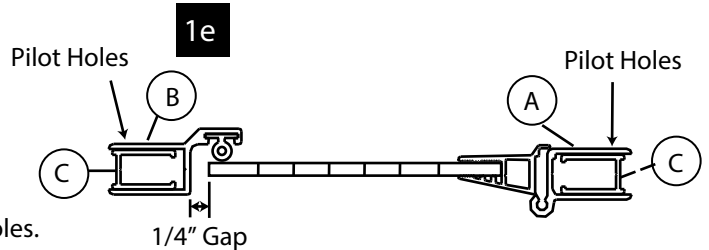

# 2.

## HANDLE INSTALLMENT

### Step 2a.

- The vinyl on the latch jamb has a notch; the handle (G) with magnet will be placed on glass and shut on notch.
- Wrap handle vinyl (J) around edge of glass, push handle on vinyl. This goes on hard so there is no movement in handle. May have to pound with mallet.
- Make sure the magnet catch on the handle is on inside of the shower. Shut door to make sure magnets are touching.

2a

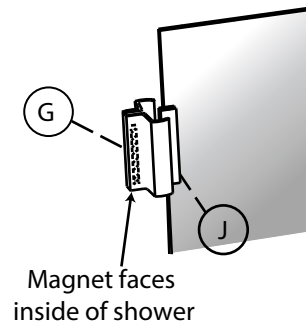

# 3.

## DRIP BAR and VINYL

### Step 3a.

- Take vinyl drip bar (H), noting there is a notch on both ends. Measure exposed glass at bottom of door.
- Cut vinyl 1/2" less than exposed glass. If door is hinge right, leave right side notch opposite for a hinge left.
- Notch part of vinyl slides under rail that is attached to glass.
- Push up on glass, making sure the vinyl lip faces in.
- Push caps (K) onto the top of wall channels (C). Cut to length for finished look.

3a

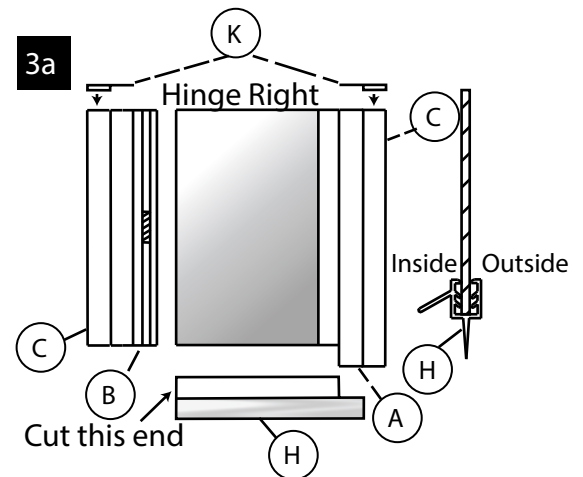

### Step 3b.

- Silicone the entire unit where metal meets wall and curb. We recommend you let silicone set for 24 hours before using shower

